

The Journal of Borderland Research

TABLE OF CONTENTS

THE ULTIMATE COMPOUND -- LITHIUM
By Haroldine. 1 - 9

FURTHER NOTES ON THE PLANETARY GRID
By John Sinkiewicz. 10 - 12

THEY LIVE IN THE SKY, Part V
By Trevor James Constable 13 - 15

TRANSFORMATIONAL MEDICINE
By Marcel Vogel 16 - 22

CLIPS, QUOTES & COMMENTS
A Proven Free Energy Generator, Peace The
21st - A Thought-Image Of Peace, The Alter-
native To War Is Peace, The Power Of Posi-
tive Thinking, On The Verge Of Ruin, Eeman
Screens Might Help Too, Shirley Maclaine:
UFOs And A Startling Coincidence, More
Wanted On "The Regent of the West", Air
Force General Killed In Crash Of Secret
Test Craft, School Prayer Advocates Know
Not What They Do, Big Brother Is Watching,
The Protective Power Of Eucalyptus Oil,
What Says The Yada About Priestcraft?, Ah,
Those Potent ELF Rates, "On A Slide Of
Light", Pyramid Stones Are Man-Made, A War-
ning About Finished Crystals, Is Rocke-
feller Dumping Reagan?, Reagan Will Find
Out Who's Boss, Hydrogen Power And Its
Problems, Report On The Integratron, and
BSRF Literature 23 - 36

THE JOURNAL OF BORDERLAND RESEARCH

BSRF No. 1 Published by Borderland Sciences Research Foundation, PO Box 549, Vista, California 92083-0190. Edited by the Director, Riley Hansard Crabb, MsD.

The Journal is published six issues a year with the assistance of the Associates, at the Director's home, 1103 Bobolink Drive, Vista. It is printed, 36 pages an issue. The Foundation is incorporated under California law, May 21, 1951, #254263, and has been in continuous existence since then. Correspondence is addressed to the PO Box. The Journal is included in the Foundation membership of \$15.00 a year, domestic. Foreign membership/subscriptions are now \$15.00. Single copies and back issues of the Journal are \$2.50. A donation of \$15 domestic or \$15 foreign will also bring the Journal to those who don't care to join BSRF. The Director's wife, Mrs. Judith Crabb, is office manager and Secretary-Treasurer.

PURPOSES OF BSRF: This is a non-profit organization of people who take an active interest in unusual happenings along the borderland between the visible and invisible worlds. In the words of the late Meade Layne, founder and director of BSRF from 1946 to 1959: "BSRA publications are scientific in approach but employ few technical expressions. They deal with significant phenomena which orthodox science cannot or will not investigate. For example: The Fortean falls of objects from the sky. Teleportation, Radiesthesia, PK Effects, Underground Races, Mysterious Disappearances, Occult and Psychic Phenomena, Photography of the Invisible, Nature of the Ethers and the problem of the Aeroforms (Flying Saucers). In 1946 BSRA obtained an interpretation of the phenomena which has come to be known as the Etheric or 4-D interpretation; it has not been radically altered since that time. This continues to be the only explanation of the UFOs which makes good science, sound metaphysics and common sense."

The chief present concern of the Foundation is to make this kind of unusual information available as a public service at reasonable cost. Headquarters acts as a receiving, coordinating and distributing center. An important part of the Director's work is to give recognition, understanding and encouragement to people who are having unusual experiences of the borderland type and/or are conducting research in any of the above fields. For consultation on borderland problems or for Spiritual healing through prayer, write or phone 619-724-2043 for help or for an appointment. Donations and bequests toward Foundation research programs and expenses are welcome.

The 37-page list of BSRF publications is available from Headquarters for \$2.50 in money, check or stamps. This includes brochures on borderland subjects, tape recordings of Crabb's lectures and of members of the Inner Circle, talking through trance-medium Mark Probert. Write to BSRF, PO Box 549, Vista, California 92083 USA.

THE ULTIMATE COMPOUND -- LITHIUM

(in solid matter/crystals)

By Haroldine

We are "front seat" witnesses to the rapidly approaching dawn of a New Age upon this planet; I feel this lithium information is both very important and essential to be shared now as it shall ease research work for many of you by providing short cuts and more complete explanations that weren't as clearly available before. So many times, what would seem to benefit us the most if we had known first, we seem to learn last. I greatly feel this is so of lithium and its vast balancing results when appropriately utilized. I take full responsibility for the theories, conjectures and context offered in this presentation.

The majority of the information shared with you today is very generalized. Should you choose to later utilize in your own research I caution you to remember--each human being is an individual, slightly different, much as is each plant in the garden. CHECK and RECHECK--there is no single blanket coverage for everything. Thereafter, though association and appropriate application, you can garner only very beneficial results.

The success of the "lithium project" was made possible by mutual co-operation of over twenty-five independent researchers, each working separately, yet mutually as a team, many who are in this very audience today. I am humbly grateful to each of you and wish to acknowledge all with heartfelt deep appreciation.

The foundation of Lithium Project was basically structured through gleanings of the discoveries/writings of Dr. George Crile, J.G. Gallimore, Dinshah P. Ghadiali, Prof. Louis C. Kervran, Dr. Wilhelm Reich and Viktor Schauburger.

I have worked in (energy) research part-time for over 20 years and began full time practice in 1979. I act as Director of Research for Lithium Labs. Ltd., San Luis Rey, California.

Lithium was discovered in 1817 by A. Arfvedson in Sweden, who while analyzing the mineral petalite, found that the sodium compounds which he separated were contaminated by an alkali which did not respond to the chemical tests for the only other known alkali, potassium. The name lithium (from the Greek, lithos, "stone") was proposed by J.J. Berzelius. First isolation in quantity was in 1855 by R. Bunsen and A. Matthiessen who electrolyzed fused lithium chloride.

Lithium is a white non-metallic metal occupying position #3 following hydrogen and helium on the Periodic Chart of chemical elements. The atom has three protons (positive charges) in its nucleus and three electrons (negative charges) in orbit around the nucleus. One of the electrons is alone in the outer orbital and so is readily lost to interactions with other atoms. When it is lost,

the lithium atom has three positive charges in its nucleus and two negative charges in its electron shell and is hence a cation: a positively charged ion that interacts with anions or negatively charged ions. In the synthesis of heavier chemical elements out of lighter ones in the universe, lithium is not on the main pathway; therefore on the earth it is present in smaller quantities compared with its chemical relatives sodium, potassium, magnesium and calcium. At ordinary temperatures lithium has a higher specific heat than any other substance except water. It is unusual in that it is the lightest of all solid elements. Its boiling pt. is 1336°C. It is never found free in nature, though traces of it occur in nearly all igneous rocks and in the waters of many mineral springs. Its atomic wgt. is 6.939. In the flame test for lithium, a brilliant magenta color is given.

Lithium is found widely distributed in the earth's crust as lithium minerals in deposits, largely silicates, of pegmatites dikes on specific ley lines of the Planetary Grid surrounding the globe. Location sources of lithium minerals in order of importance are:

1. North America and Canada
2. Africa
3. South America
4. Australia
5. Europe

Calculated to be approximately 0.004% or a comparison of lead as 0.002% and tin 0.0006%. The major lithium minerals of commercial interest are:

1. Tourmaline (approximately 1-1½% Li_2O)
2. Lepidolite (approximately 3-5% Li_2O)
3. Spodumene (approximately 8-8½% Li_2O)
4. Amblygonite (approximately 8-10% Li_2O)
5. Petalite (approximately 2-4% Li_2O)
6. Desert lake brines (approximately 22% Li_2O)
(0.03% Li_2O in brine)
7. Eucryptite (approximately 8% Li_2O)

The commercial use of lithium in earlier years was mainly in ceramic industry for producing glazes and specific grades of glass. In the automotive industry as an additive to keep oil from breaking down. During WW II lithium was used on submarines to neutralize possible escaping chlorine gas. Lithium has been used for many years in the manufacture of pharmaceuticals, such as the antihistamines because of its stability advantage and as a reagent to produce synthetic vitamins. To a limited extent, lithium is used in the metal industry in various alloys increasing tensile strength and resistance to corrosion. It is also used as a desulphurizer and dioxidizer in copper and as an additional agent to magnesium, aluminum, and zinc based alloys as well as a hardening agent in lead alloys. It is used to purify helium and argon by removing nitrogen and oxygen. Lithium is now being utilized in batteries for wrist watches, pacemakers and

testings done for automobile batteries. Improvement of 1/4 the wgt. and 4 to 5 times the shelf life. In early 1940, "Seven Ups" soda pop use to add it to their soft drink with advertised caption: "Takes the 'Ouch' out of the grouch!!"

In the medical field, the use of lithium carbonate for treatment of manic-depression has been reported very successful. Within the last three weeks (June '83) there have also been large successes reported for treatment of individuals addicted to alcohol via application of lithium carbonate. American physicians were excessively cautious because of disastrous results when applications of lithium were substituted for sodium in treatment of congestive heart failure. Several patients had died before physicians had realized the toxicity of lithium in a patient deprived of sodium. Because of this misfortune, lithium's use in the United States was delayed approximately ten years though it was used in Europe and Australia earlier.

In esoteric writings, it's stated that Planet Neptune rules the 3rd Eye (6th chakra) and its metal is lithium. This opens the pathway to higher consciousness or more "human potential release". Lithium is an essential constitute of every cell in a healthy human body. It is utilized in the building fibre of cell walls of every cell and is one of the main ingredients in the covering sheath of outgoing nerve endings. Lithium is primary ingredient of crossover from etheric to physical in human formation via the conception and governing meridians. This has been checked and confirmed by several radionic practioners. This is newly discovered information for Acupuncture though this Art has been practiced over 5,000 years. How many of you are aware when the hydrogen bombs were dropped over Japan in 1945--the residue product remaining after the hydrogen and oxygen atoms were smashed together at great pressure was lithium? Is it possible the success of Japan's technical progress could have been influenced by the lithium materials floating downward thru space to their islands? Lithium ore dust is being used as part of materials for dental fillings, it assists to keep patients' meridians aligned in dental research.

Towards the very ending of T.V. program I was watching early one Saturday P.M. almost five years ago, a statement was made that strongly called my attention, "that fresh water pools rose up out of the salt water in an area around Bimini. Folks who bathed in these fresh water pools had their skin cancer healed within days. When the fresh water was analyzed, it was noted it contained a high percentage of lithium."

'Til that moment in time, had never even heard the word - LITHIUM - and had no idea what it meant. That began the quest to know and understand lithium: First the dictionary and then a visit to local rock shops. The greatest surprise of all then happened... there a was large lithium mine located in mountains only twenty miles from the town in which I've dwelled twenty eight years on and off, located on an Indian Reservation. Seasonal tours were conducted each Saturday and Sunday and I signed up for one. Part of the tour,

one was allowed to dig in the tailings dump. The main attraction at the tailings dump was the search for tourmaline - a precious gemstone containing 1-1½% lithium. I later found out tourmaline was used in atomic submarines and nuclear warheads as well as jewelry. Tourmaline is the second fastest conductor of electricity upon the planet being surpassed only by the Human Mind. There were huge piles of lovely blue/violet "rocks" all around the tailing dump that everyone seemed to ignore. The color of their beauty strongly attracted me and so began my love affair with lithium crystals/ores/minerals. Brought varying samples home and had Kirilian photographs taken. The ore's energy was strong enough to show up on finished printed photograph as three tiny magenta color, heart shaped figures from the sample of blue/violet ore called lepidolite. (Having remembered from reading in a book called "Vibrations" that told of color teachings/writings of Dinshah and special value of color, MAGENTA:

"The two remaining colors, green and magenta, form the 'North' and 'South' poles respectively of the circle and constitute not affinities but dual primal forces of the same energy working as a single factor, like the poles of a magnet. Dr. Mac Naughton refers to them as representing the 'Primary Force' and 'Kundalini' respectively.") This was silent signal there was something very special about this ore energy and so began the "lithium project". [Magenta color represented "primal ground force vital energy"!!!] During the first mine tour visit, I also observed the foliage around the mine and tailings dump was exceptionally tall, large, and very green. Whereas other plant growth was similar high desert 12"-14" stubbles. The young miners who lived close to their work in trailers had planted a garden. The tomato plants were over ten feet tall and the corn plant stalks towered at twelve feet. This was in latter part of October when normal growing season had long since ceased. Watermelons harvested in December though small in size were sweet and tender. Decided something special had to be affecting ground for this type plant growth to occur. Started using some of the lepidolite crystals as type fertilizer on my patio and sent similar crystals to fellow researchers around the U.S. to note affects in their area. A dear friend in Chicago who had received several batches greeted me at Dayton USPA Conference with loving comment: "For--sakes, don't send me any more of those purple rocks"...now that he understands more of their workings, feel he may have changed his mind. At same time, recorded research data for work done with avocado groves in Fallbrook, California. The lithium ore were encased in cloth wrappings and secured 360° outside around the irrigation pipes that watered the groves. One grove was watered separate with different pipe and kept as a control. The water rushing through the pipes created an energy current that picked up the "frequency" charge from the lithium crystals. The main important changes noted was the blossom set increased from 75% to 90%. The nutrition of fruit improved approximately 22% in just a three-month period. The grove that was not treated and used as control became pleasantly contaminated in positive way as the healthy charge from treated groves leached over into untreated groves. This was

our first recorded experiment of lithium crystals contribution to agriculture.

Concurrently, appropriate application with lepidolite crystals were tested with human energy and beginning affects were noted that greatly contributed toward balancing or centering. Because lithium has both left or right polarity swing, a multitude of report results were noted merely by carrying crystals in left pocket. Sort of like filling in several different blanks, depending upon specific need of the individual. Hyperactive children acted more relaxed or calm, as crystals afforded more grounding energy support. Some of the lepidolite crystals were ground into dust-type substance and sprinkled on drop of colorless nail polish in center of each toe nail and allowed a grounding support energy for individual for up to two weeks. Fragmented type personaltiy individuals blended more towards center/balancing with the lepidolite crystal grounding support, also. Some of the lepidolite ore was sewn inside 1½" cloth squares and research volunteers carried on their person or slept with packet tucked under their pillow. (I suggest maximum exposure to any crystal no more than 18 hours a day in your aura or maximum of 8 hours exposure if sleeping with crystal's radiation. The body needs a certain amount of time every day to be totally alone with itself.) One research volunteer, female approximately 55 years of age insists, wearing the cloth packet in her left bra cup cured her constipation problem. Another volunteer, male, age 42 who truly fitted title of "Space Cadet" upon carrying packet in his left pocket became more grounded, relaxed and balanced in his every-day function via occupation and home family life.

From writings of J.G. Gallimore I noted, "one out of three people are born 'sensitives'." Very few folks have understanding of this happening and few who are affected realize little about it. It's as if certain folks have DC wiring and sense all energy flow with no filter whereas the other two of the three are born with AC current. Use of the cloth cover lithium crystal packets tucked in left bra cup of two ladies naturally born sensitives gave grounding support and they no longer felt hyper.

Wm. Conners who had done vast research work with tone and number harmonics found that lithium has a fundamental harmonic that resonates with every note of the musical scale. I feel this is why lithium offers such diversity in its many varied areas of application.

Lepidolite the blue/violet "rocks"--a lithium crystal I found so attractive in color my first visit to a lithium mine was found to resonate with 5th or throat chakra. (The thyroid/throat area is where all the electric potential is stored for the physical body.) An eight year old psychic male child shared lepidolite "calls the healing angels for human beings"; quartz crystals "call the healing angels for plants".

Am not sure how many of you may be familiar with Professor Louis C. Kervran's research work done in France over the last twenty five

years, which he referred to as "biological transmutation". (Prof. Kervran died Feb '83) He discovered that in nature, a property of matter is the phenomenon that transmutation occurs. One natural element can change into another. The results obtained have nothing to do with the reaction of nuclear physics since biological transmutation involves neither fusion nor fission. Kervran referred to it as a science different from chemistry, it precedes chemistry or molecular state. Prof. Kervran's hypothesis of transmutation realized there is always a modification (in the nucleus of the atom) equal to the displacement of a hydrogen nucleus or an oxygen nucleus suggests new incite into the role of both these vital elements. Those familiar with Dinshah's discoveries and writings, know that over 50 years ago he expressed his theory that the only two true elements were oxygen and hydrogen; at that time Dinshah was not 100% sure that even hydrogen was a true element.

After working with lithium crystal and observing affects, I feel hydrogen is more a transitory state and not an element in our present known definition of an element. I strongly feel, again mention that lithium is the main connection from etheric on into the physical plane and is primary formation of human life via our nervous system--the "entrance in" so to speak. The "entrance back out" is adequate lithium supply in system to allow the natural opening of 3rd Eye--our pathway to higher consciousness or more "human potential release". "Hang ups" or subconscious "fears" lessen the lithium production by the anatomy and various forms of self-destruction replace the higher consciousness possibilities. I liken the ingredient lithium to human body, as a wick to a candle. One still has to light the flame, however the basic ingredients must first be available for flame to burn. Aldous Huxley's "Doors of Perception" may offer incite to research specialists presently working in this area. It has to do with how adrenochrome is broken down and transmuted by the body. Those of you familiar with Nicola Tesla and may have read his biography, "Prodigal Genius"--were you not curious why Tesla developed his habit of hyperventilating in early youth and continued doing so all of his adult life?? I feel Tesla was transmuting his own lithium manufacture to keep his higher consciousness pathway door clear and open. Somehow, I feel by his hyperventilating, burned up impure carbons and sulphurs that otherwise might mineralize; causing complications and collect in physical anatomy, creating "short circuits".

I forwarned at the very beginning of presentation--am offering very general information. Those of you who are specialists and experts should now have some very specific "seeds" to pursue answers which will greatly benefit many of mankind. Lithium offers many, many solutions to a very vast range of human imbalances--it can restore balance and health.

During the four-plus years of "lithium project" we found seven individual lithium crystals that could mechanically activate the seven major chakras. These lithium crystals also assisted the volunteer researchers in specific areas to problems they'd not before been able to solve. (Seldom is there a single problem in physical

body, very subtly its but on indication of inter-connection to misaligned nerve connections and the most severely afflicted areas focus first.)

Chakra and Lithium crystal(s)
7th - Rose-lepidolite
6th - Tryphane
5th - Lepidolite
4th - Kunzite, (Pala Pink) tourmaline
3rd - Petalite
2nd - Royal Azel
1st - Hiddenite

The research with each of these specific lithium crystals was applied in many different ways. Will share single reporting of each:

Tryphane: By sleeping with crystal during nite time restoration of body. Its affect was found to erase the action-track patterns held in the white matrix area of brain that were no longer essential for the highest good of the individual.

Royal Azel: Activated with spleen area and assists the inter-connection contact to again activate the thymus gland (youth gland) which greatly dissolves excess friction and supports whole nervous system.

Lepidolite: Earlier mentioned as contact to 5th chakra reduces stress (stress takes many forms, high blood pressure is one of the greater offenders). This area is seat of human emotions and these lithium crystal creates more balance or allows more "humaness". It greatly eases depression for those who suffer from mood-swing chemical imbalances in anatomy.

Hiddenite: Affects the 1st (root or base) chakra traveling downward to minor chakras in leg(s) and knee(s) plus upward contact to the parotid gland located in cheek area of the face. (The parotid is where human anger is stored) this lithium crystal eases relief in small puffs rather than huge smoke explosions.

Tourmaline (Pala Pink): Was found to bring balance to emotional body of heart chamber, much as one could imagine two velvet gloved hands stroking and soothing.

Petalite: Activated 3rd Chakra which brings in the "Christ Consciousness" or "Faith" area. Its centering action is via gut area.

Kunzite: Strongly tied in with 4th Chakra. It's frequency also assisted to align heart, throat and ajana (mid-brow) centers. It gives very strong supportive energy to heart chambers.

Rose colored translucent lepidolite (Brasil): Toned in the 7th Chakra and blended the other individual six lithium crystals into major chakra alignment.

Approximately three months after completing the series of seven individual lithium crystals to mechanically activate the seven major chakras, a single crystal came forth that did the work of all seven lithium crystals within a twenty-four hour period. It is called "Golden C!" It is a combination of both lithium and beryllium and from freak deposit in nature. It was named by lady in San Anselmo for its rarity; it cannot be found discribed in any gem stone book. Its radiation color is pure gold light. It also affords marvelous assistance to rid aura of "Uninvited Guests" and releases them to "LIGHT". It does similar for radionic instruments.

The last part of June 1983, entered two more lithium crystals - Polyolithionite: works via base/root chakra and adrenals and when utilized with radionic instruments protects patient from becoming striped of minerals in treatment. Much more research testing is required before this lithium crystal can be made available. The other new crystal is Amblygonite: facetable material first were located in Brasil in 1975 in new found deposits. This contains an extremely high vibration--possibly around 13th chakra--there has not been enough research work done yet to share any more about this crystal therefore it is not available for others use at this time.

There are many more uses and applications for lithium/crystals--today, I wished to present general over-view of what is available already as "tools" that may assist the suffering human towards balance, naturally! There is vast range to be explored in lithium research which will bring forth almost immediate solutions compared to "tools" we've had to work with in the past. Specialists in the field of research will be aided greatly by allowing lithium to fill in some of their blanks.

Along with the crystal research during "lithium project", we also worked with AQUALITHIA, a natural mineral water formed 800-1,000 ft. below sea level in the earth. It has many unusual properties. When it was biomagnetically analyzed the only complete element found was neon. AQUALITHIA is diamagnetically negatively charged high grade tellurian water. It remains stable after long exposure to light though storage away from heat and metals insures even longer shelf life. A few drops (pendulum checked) added to 8 oz. glass of regular water; wait 5 minutes and then drink; causes body to become almost like a sponge that absorbs more natural healing color rays from the sun. It acts as a natural chelator for the body dislodging lead, cadium and other toxic metals from system. It removes plaque from the arteries and waste is discharged naturally, with no side affects. It unlocks the "gates" for trace minerals residing dormantly within body to again activate so they may complete their natural intended functions. Sprayed upon aching joint or heat burn, immediately removes the pain. Almost immediately removes jet lag from weary traveler by realigning all the body meridians. If one has consumed too much alcohol in happy celebration, the alcoholic affects can be removed and individual totally sober in five minutes; this, of course, eliminates hangovers. Spray mist of AQUALITHIA in face create "natural high". Delays break down/decay of fruit/veg. additional 3-5 days or longer. It revitalizes kitchen cooking oil--yes, this water and oil mix!!! Neutralizes allergies to cosmetics

for men and women. Provides a natural deodorizer for room freshner and even cat boxes. When encased in small pyrex bulb and stroked across mid-throat area acts as stress reducer. When transplanting seedlings for replanting in ground, prevents shock so plant is allowed 2-3 days advance growth. Sprayed in mouth, clears onion and garlic breath.

Both lithium crystals/ores/minerals and AQUALITHIA display some very unusual nitrogen fixing properties that eliminate the need for artificial fertilizers and pesticides in agriculture. At the same time applications benefit growth and nutrition of the plant, it also is balancing soil for future use. (With use of lithium "tools", what naturally would require one full year from Mother Nature can be completed in three months).

Because of lithium's ability to interact with normally inert nitrogen and its interaction with hydrogen, I've chosen to consider LITHIUM - THE ULTIMATE COMPOUND via its workings with matter.

Thank you for your kind attention and allowing me to share with you today. I again wish to acknowledge all the individual researchers who made today's presentation possible! There is now 5-minute question/answer period available before the "lithium crystal(s)/chakra demo"!!! Lithium Labs, PO Box 96, San Luis Rey, Cal. 92068

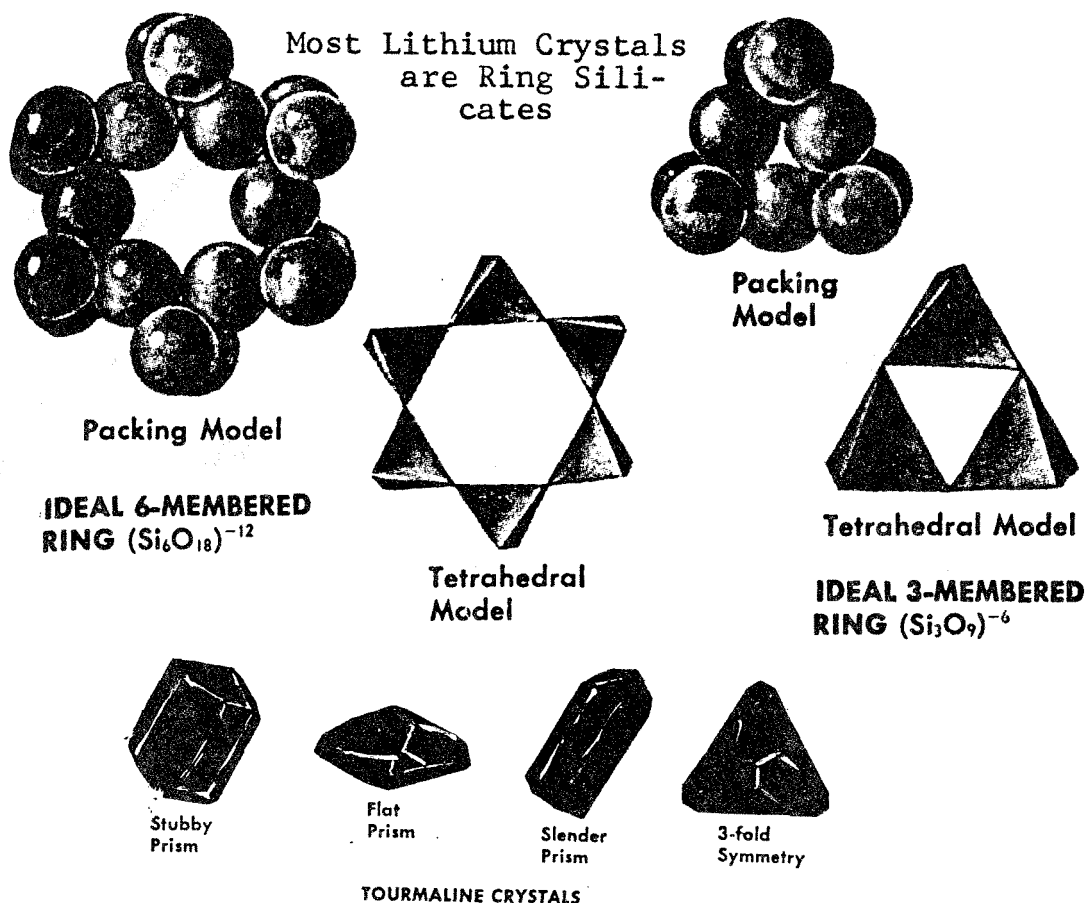

FURTHER NOTES ON THE PLANETARY GRID

By John Sinkiewicz

When talking of an Earth Grid or lay lines, many of us on one hand seem to be saying the same thing and on the other something quite different. There is, of course, an answer to this seeming divergence. There are two Grid networks or webs, plus the third element - the "physical" results of the interplay of the two.

It is this fact that Mr. A. M. Davie, of Scotland,* seems to have uncovered in the development of his "Catastrophe Theory". Thus, if this be so, it might be that Mr. Davie's theory can provide just the data to prove the two grid existence. likewise, this theory could illustrate the interworkings of the grids.

When I speak of two grids, I am not in this case speaking in terms of the old grid and the new grid, for in this format, I

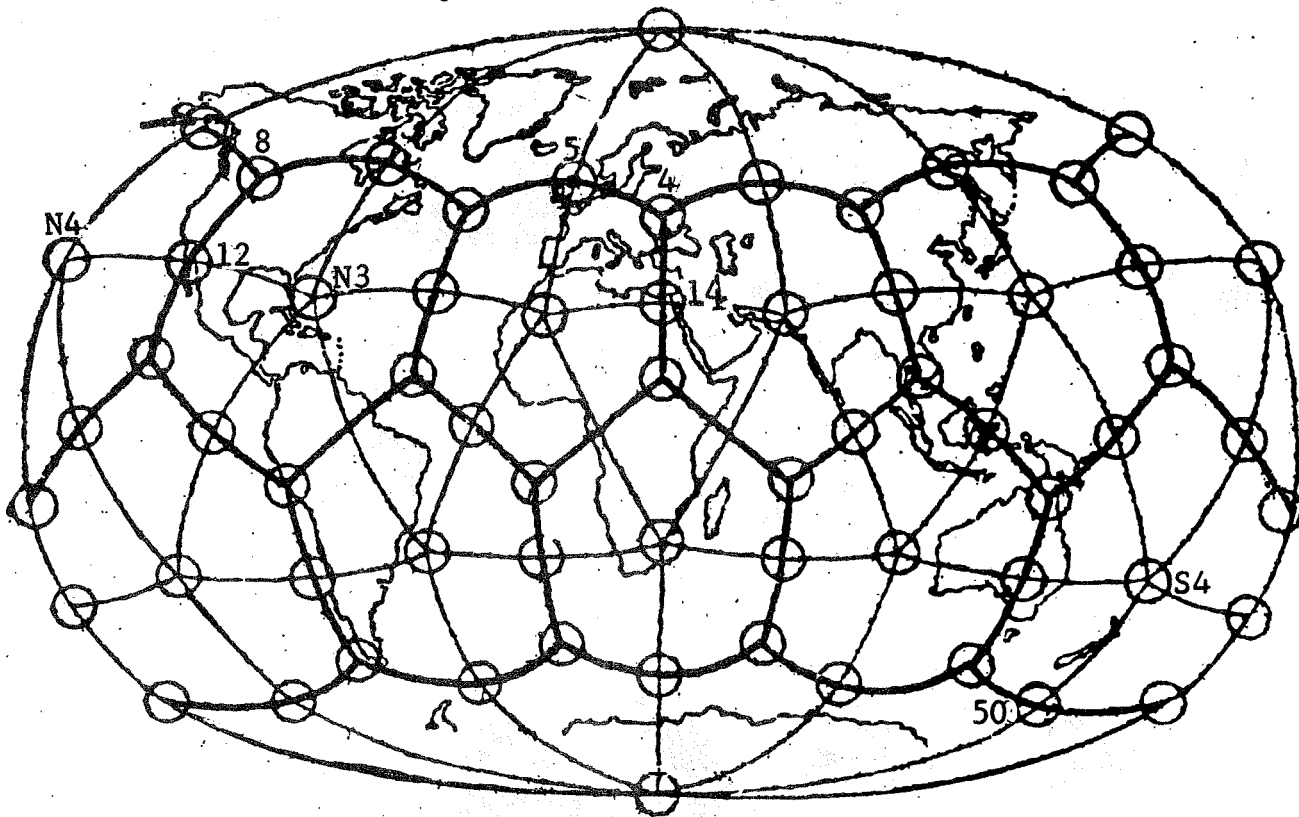

The World is a Crystal, an Icosa-Dodecahedron

would have to speak in terms of there being four grids.

The two grids which I make reference to are called, for the sake of names, the Etheric Grid and the Astral Grid. Though these names are but that, a means of distinguishing one grid's activity level to the others. One being causal in nature, the other being re-active.

The common tie points or "golden spikes" are the reason for so much confusion on the grid issue. The "golden spikes", as I call them, are the twelve energy nodes (plus the central sun meeting point) on the earth grid pattern. They correspond to the chakras in the "human" planet. With the exception of these "golden spikes" (and perhaps what might be called the intervening "silver tacs") the two grids have quite different make-ups in each locale. Essentially the etheric grid forms the pattern, while the astral grid forms the re-active or emotional correspondant. This is sort of like a garment with a lining. The outer fabric establishes the set (or form) of the garment while the lining might be at any given point or locale quite differently arrayed, yet both have the overall garment and seams in common.

In certain parts of this globe there is a close match with the two grids and harmony abides. Other regions are widely askew from harmonic alignment, resulting in emotional chaos, a region ever in turmoil. It is in a desire to bring these two grids into harmonic resonance that the "workers" of the world are trying to institute balance into troubled regions by supporting programs which induce; good health, better diet, better housing, etc.

There are very specific means that one might employ to their locale to increase the harmonic content of that region. The simplest of these are written of in all of the great books; "love thy neighbor", for this thing called "love" is actually the force or energy which results from perfect balance of the two grids. Thus you see, love can move mountains, literally, for from a base of love, one is able to work from the etheric vantage point, the point of cause in all material effect.

It seems that Mr. Davie, knew this, though not perhaps consciously, but within. For he brought forth a means of instilling love (balance) into all things, animate or inanimate. He achieved this by developing a formula that would dissolve the imbalance locally, thus producing spectacular results on inanimate objects as well as humans. It seems that the essential reason Mr. Davie was able to bring this understanding to his consciousness was through recognizing the astral grid with its associated distortions. Once recognized, his sub-conscious was able to tie in the promise of balance by synchronous matching of two energy patterns exact in nature but distorted in function.

This, also, might help many to understand the oft spoken phrase "emotion is the antithesis of love" for where emotion presides, imbalance resides.

Now that an option to understanding the varieties in grid research has been outlined, we can begin to experiment with the possible realities available. For an interesting first experiment one might consider developing a device whose very nature and form exhibit balance. Then if this device were to contain within its confines a means for energy accumulation and draining, we could then locate such a device exactly on one of the etheric grid intersections (these are geometrically fixed), then with an antenna, charge the device with energy from the astral grid and pump it directly into the etheric grid intersection. The inevitable result being a synchronous lock of the two grids. Now, this device would be a natural dynamo, producing vast amounts of energy, electro-emotional in nature. Needless to say, that device would not only be a local infusion of love (balanced energy) but could be channeled to provide all of one's needs for energy forever.

When one considers which forms fit the above criteria, two forms should immediately jump into mind, the sphere and the tetrahedron. Though there are others with greater complexities to their form, the sphere and the tetrahedron offer simplicity to their usage. If, for example, one were to build a tetrahedron as the charging form and the sphere as the accumulating and discharging form, much could be developed through experimentation.

THE TETRAHEDRON, A Three-sided Pyramid with Base. All Sides and Angles are Equal. If we put this four-sided figure at No. 4 on the Tree of Life it implies a masculine center in the body of the Solar chakra is the planet Jupiter and this signifies "honor, glory and Sinkiewicz' choice is a fortune-
 line force Logos to the riches", ate one.
 have drawn in our idea of sided antenna for each of as suggested by him, as tral sphere in this Orgone
 the four well as accumulator.

at No. 4 on symbolizing whose mundane Cabalist so John Here we three-surfaces the cen-

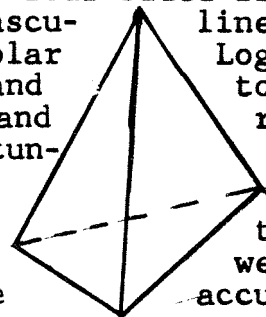
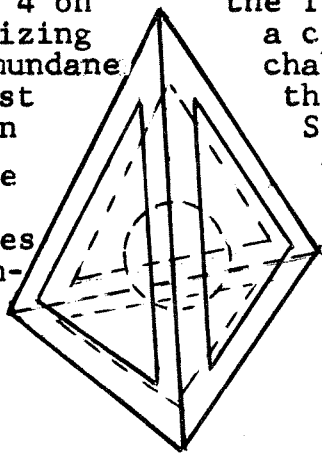

Illustrations by the Editor

By considering each face of the tetrahedron as a plate battery, all four of which fit smoothly together into an overall charging device, some interesting options develop. For example, each face

could be constructed like a triangular doughnut with matching beveled outer edges. This doughnut could be made up of a basic wood frame with its form developed through alternate layering of say sheets of wool and aluminum foil. Now, we should have a natural accumulator for emotional energies. An antenna could be developed by winding a wire through the doughnut form like a triangular toroid coil. If each such coiled face were balanced so as to have the same resonance, the resulting cavity would be a harmonic resonant cavity.

For drawing off the charge accumulated in such a cavity, one could mount a metal sphere in a non-metallic saddle in the exact center of our cavity. If this sphere had a lug like means for connecting a good gage wire, the possible result could be a form of electricity electro-emotional in nature.

Since, of course, balance (or Love energy) is our goal, we might size this device with the ratios of the earth and the moon. For example, the radius scribed from the center of the tetrahedron to one of its points would represent the radius for the sphere for the earth. The interior metal sphere would be the moon.

Caution would be the by-word of this area of experimentation since our initial charge is emotional energy whose over charge we all know could be chaotic, if channeled into the human psyche. Thus, one who is well balanced in their emotional make-up would be rewarded with the best results.

John T. Sinkiewicz
L.I.F.E. Research Corp.
3206 Debbie Drive
Hendersonville NC 28739

* A.M. Davie, FFB FGS
32 Norwood Avenue
Alloa FK10 ZBY
Scotland



Nicaragua admitted today to mining New York harbor to force the United States to change its government to one that is more acceptable to Managua.

THEY LIVE IN THE SKY

By Trevor James Constable

Pertinent Excerpts From A
Flying Saucer Classic Of
The 1950s, Part V

The UFO picture was still far from complete, even though the communications from Ashtar were filling it in quickly and with bold strokes. Sometimes shocked, sometimes nonplussed, I nevertheless found much that was contained in these communications to be true. In many instances, explanations came to hand for observed phenomena, although these were not always direct answers but rather signposts for the direction of one's reasoning power.

Some information had been offered about the various types of craft, now the question arose of the crews, what were the occupants of these craft like. . . in the case of the machines purported to come from the center of the earth?

Trevor: "By whom are these craft manned?"

Ashtar: "They have a variety of beings in their craft. They may be human type entities in the astral body, in every way similar to yourself. They may be elemental sub-human slaves of the astrals, or they may be astral monsters of a proportion and type likely to fill you with terror were you to contemplate them. In your measurement, many of them are gigantic, and horrible to behold. The craft may be manned by any or all of these creatures. . .

"The silver spheres frequently reported, especially those associated with reports of little men as occupants, are a type of craft launched from the carriers of the dark ones. There are several facts which govern the sightings of these things. In the first place, a combination of atmospheric conditions and the physical condition of the viewer may render them visible. In the case of the monstrosities seen by only one person, this may be the case. Certain physical conditions of the viewer may render them visible to one man when they will not be seen by another man beside him. Hence the common term 'hallucination'. But the man who sees these monstrosities is seeing something very real, and while it can be said that the experience is a subjective one in a sense, it is also a view into the unseen worlds which surround and interpenetrate your own. Great confusion is caused upon your surface by the varying descriptions of little green men, little men in various types of clothing and so forth. Believe me, it would take many books to fully describe the many types of elementals who dwell in the invisible realms."

UNPALATABLE MONSTERS

There have been instances of pilots seeing some of these Saucer entities and going out of their minds as a result. One such incident, presented in what amounts to hearsay form in Major Keyhoe's "Flying Saucer Conspiracy", concerns an Air Force pilot in Hawaii. Sent up on a UFO scramble, he was alleged to have landed in babbling terror, after having seen the occupant of one of the UFOs.

The Pearl Harbor incident harks back to Oct. 8, 1953 when a voice suddenly cut in on a Salt Lake City radio station and proclaimed "I speak from a space ship. You cannot reach me, but I can, with ease reach you. If you saw me, I should be so horrible in your eyes that you would be scared to death."

Trevor: "Are the dark ones craft propelled by the same propulsion system as yours?"

Ashtar: "No. They use an electromagnetic drive on some of them. Others are propelled by a jet and hydraulic system. That their propulsion systems are less than ours is indicated by the fact that they have a maximum speed of 3500 mph in your measure. The different propulsion systems give rise to the different light manifestations, although these are a rule of thumb and not an arbitrary and fixed method of identifying the different types. They also have discoidal machines similar to our ventlas."

Trevor: "On occasions, elementals have been seen stealing water, or water has disappeared in large amounts following Saucer sightings. Why is this?"

Ashtar: "Water is a valued commodity in the center of the earth where they dwell. One of the reasons they come to your surface is to steal water, which they do from lakes, rivers, reservoirs and tanks as convenience dictates."

I first stumbled into the concealment aspects of the UFO at the Spacecraft Convention held at Giant Rock, California in 1956. My attention became drawn to a section of the sky beyond the head of Frank Scully, who was speaking at the time. I saw several clouds appear and disappear in a strange fashion, for they hung motionless and unaffected by the wind that blew quite strongly. I noticed that the vapor trail of a high flying plane was rapidly dispersed, while these clouds continued to materialize and dematerialize.

I took off on foot across the desert for perhaps a couple of miles, until I came to a point just below the clouds. One thinned out and began to disappear. I perceived a reddish glow with a rotary effect within it for a few brief seconds. Then, about a minute later I perceived the reddish glow once more, but it was obscured almost instantly by a condensation of vapor which gave the appearance of a small cloud. . . From this series of events I deduced that as the craft became visible, for some reason or another, it was capable of condensing water vapor around itself, remaining invisible to the eyes, even though it was probably at our visual frequency, inside the cloud. (To be continued in the Sept-Oct Journal)

TRANSFORMATIONAL MEDICINE or CRYSTAL HEALING
WITHOUT DRUGS OR SURGERY

Transcript of Lecture by Marcel Vogel at the
Holmes Center For Research in Holistic Healing,
Los Angeles, December 1983, by Albert E. Fry

I talked on Holistic Healing at your first Symposium here in the Church of Religious Science ten years ago, 1973. Now, after ten years of more research, I have developed a new technology, Transformational Medicine. The talk I share with you now deals with the Knower, the true identity of Self, the Soul.

Man is made in the image and likeness of God. There is that Divine Spark in each one of us. Our purpose in living is to exemplify by actions and by reflections on these actions, that divinity that each one of us possesses.

Yes, periodically we go through what we call suffering. I look on suffering as a tempering of the body to handle the energies of the spirit. As steel is put into a furnace and heated up to a red heat, and when it gets to a critical temperature, an impact of the blow of a hammer causes the molecules of iron to flow together and adjust themselves to a more flexible and malleable pattern of movement. Instead of being torn and riven they are tough and strong. This, I believe, is what we experience in our bodies when we go through the rigors of life and what many people call disease.

In my lifetime I have had the experience of death and rebirth. At the age of six I came down with double lobar pneumonia three times within one year! The third time I was given the Last Rites of the Roman Catholic Church and totally prepared for transition, and the transition process began to take place. I separated from my physical body. I experienced what other people have experienced, the Divine Light, that Luminous Cloud. I became one with that Cloud.

As I moved out my seeing was that of an anamorphic lens. The entire room -- doctor, priest, my parents -- became smaller and smaller. There was a tunnel which I was approaching. Then in one moment I was back in my body! The next day I was well and running around like any other child. I asked my parents why am I alive? What is the purpose of my living? What am I to do with this life that has now been given back to me? And I ask the same question of you, my friends, that are here at this Symposium.

I found that there were no answers from any individual or book.

I read voraciously and asked innumerable questions, and no answers were forthcoming. I had to go within. That meant going to 5:30 Mass in the morning and praying for illumination. The bridging of the bond between the Lower and the Higher Self so the Knower can come through and speak in clear voice, that is the power of prayer! It is to lift the mind and heart so they come together in harmony and contact the Spirit, the love of God within each one of us. That took four years, from the age of six to eleven.

ASK AND YE SHALL BE ANSWERED

One morning a voice spoke: "You are to be a chemist. You will write a book in the field of luminescence -- a specialized field of phosphor chemistry. You will form your own corporation and design rare earth phosphors." That was an explicit answer to a directed question four years long!

How many of you here now are ready to wait four years for answers where nothing is forthcoming day by day? Please, never lose patience when you pose a question because the answer is forthcoming.

Each of those statements was brought about and built and executed in my lifetime. The book was written, a doctorate at Princeton on "Luminescence of Liquids and Solids". I started the Global Luminescence Corporation and had it for 14 years, until I joined IBM. I've done the development of rare earth phosphors: Ytrium, Benedate, Europeum, for the purpose of fluorescent lamps and color television.

Then there was the challenge of Clive Backster's work with living plants, demonstrating a telepathic link between himself and the plant. I derided his work at first and set out to disprove it scientifically with my own sensitive meter, a graph paper recorder and a Philodendron. That plant became my teacher! It changed my life! I saw that when I think an energy emerges from my body. I saw also that that energy has a precise pattern to it. I learned also that that energy is controlled by breath. As a man breathes so is he. The science of breath is vital and necessary for every individual who wishes to be a healer, to be an endowed or evolved individual. That knowledge is ancient, known to the Hindus and the Tibetans and is in published literature. I have a book here by Swami Ramachakra, "The Science of Breath". There are many others that you can get.

The study of Yoga -- meaning "union" -- brings one to the deeper knowledge of this magnificent controller of our body functions, breath. Through breath we move to various levels of consciousness to emit or manifest these energies in space.

Does this energy have spatial limitations? From the experimental work that was done with Dr. Ward Land (might be Lamb) and myself, we published in "Psychic Exploration": "A Challenge For Science", we found that even though 8,000 miles intervened between myself and the equipment we set up in Dr. Land's office in San Jose, California, there was no attenuation of the pulsations or signals that were sent out from me. When one learns to connect with another life form with breath, one establishes a "carrier wave". Each one of us, either

the living or the non-living, when we have a physical form, that form is radiating a vehicle, an energy field; and when we breathe, and draw our breath in and release it, we establish on that carrier wave a modulation of that signal. This is the record in space of ourselves.

We exist both within and without our bodies. Man is not only composed of matter; but, he has the power of a spirit or breath functioning within and around him. A study of that breath is my life's work from this moment on. What the nature of that is, what the forces are connected with, and the way we can serve one another in the proper use of these energies.

MASTER TEACHING THROUGH THE AGES

This knowledge is known by the Masters, down through the ages. One of the great wonderful teachers was Jesus Christ. He gave us much in the 33 years of his life on the dignity and power you and I possess. All of the things I do, said Christ, you my friends can do in like manner, but even greater things, because I will be with you.

How many of us here ever truly believe this to be a fact? That we can help the blind to see, the deaf to hear and the lame to walk? How many of us have truly tried to do this with one key attitude: the power of Light, not the --?-- agent, not denying it; but just loving one's fellow man. That is the teaching that I drew from the actions of Christ, loving one's fellow man. But deeper than that, using the mind of a scientist -- a spiritual scientist -- I was given clues to know what to put together in physical form to amplify these signals.

In 1973, after I'd finished the lecture here and went home, Dr. McKestry, one of your ministers here in the Church of Religious Science, called me on the phone, and said, "I have a crystal that oscillates. It vibrates when you hold it in your hand and I would like to send it to you." I didn't know how to respond. I said, "Why do you want to send me this crystal?" He replied, "I feel impelled to send it to you." "If that is the case, do it."

That changed my life again. It was the transition from plant experimentation to the understanding and the use of single crystals of quartz, an amplifying system for these energies of the mind. From that crystal Dr. McKestry sent me there evolved ten years of trial and error experimentation, travels

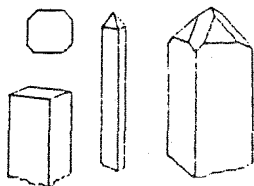

TETRAGONAL

throughout the world and over a thousand books that I pored in and found nothing. I had to go within and pray for guidance. Because what I found with my senses was a frightening thing. What I found was what one could do with a crystal. It was awesome and had the aspects of intergalactic warfare! I wanted none of that! I said, "If I cannot use it for the good of man I will have no part of it", and for one year I

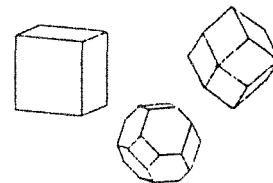

ISOMETRIC

resisted doing any form of experimental work. I'd pick it up, do a bit of experimentation, and put it aside.

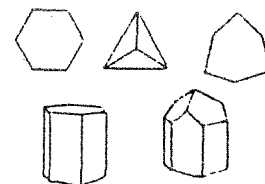

GUIDANCE FROM NIKOLA TESLA?

One experiment we did I will share with you now. Could we produce electricity with a crystal, in a special device? We designed it. We built the coils derived from the knowledge and writings of Nikola Tesla in his Colorado Springs experiments in 1899. I had eight people in my living room. The coils were connected in cascade. There were three sets of coils attached to the center crystal. It was hexagonal, like you see here. There was a face plate attached to it. There was no power in the crystal. The two leads went to a galvanometer. When I "pulsed the breath" and went "into the crystal", 75 volts of steady DC field were produced! It remained steady for at least two to two and half hours. When I withdrew the breath the field stopped. I dismantled the equipment and will not make any future device like that. I looked ahead, into the future, of the implications of these forms and felt not capable -- or desirous -- of pursuing that avenue!

HEXAGONAL

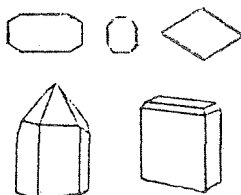

ORTHORHOMBIC

I had one step function like another in these approaches. Every form of glamour that you can imagine was offered. I said no! I want one device. That device is to be of service in healing and that is what emerged, in a way, in a truly wonderful way

I sat down one day after lunch at IBM, with a woman who is the manager. I said to her, "Let's see that I am to do with these crystals for the service of mankind!" Suddenly the body of the woman changed and a man-like voice came from her. "You are to cut these crystals in a di-pyramidal shape", and (she) sketched out a rough drawing from which now these crystals have been made.

That was in 1975. I started working on cutting that shape on a large, 14 inch diamond saw. I had absolutely no experience in cutting, faceting or finishing stone. It was not my province or skill. I had to use an inner guidance system. That was done. This work was done at lunch hour, after hours in my work in Bldg. 28. After one year the first completed crystal was made. I then started the process of learning how to apply it to the subtle bodies of man. An enormous amount of stumbling had to be gone through, trial and error, as to where and how these were to be used and applied.

I take a crystal, focus it on the faceplate of a photomultiplier tube (used in TV cameras) and a pulse of energy can be seen on the electronic scope. I take the crystal, separate it from myself, stand back five feet, build up a charge with the breath, release it and you see a signal, a very rapid signal, on the scope.

I now have with me the last remaining Thought and Photography camera, the Mark IV Delawarr Camera, made by George Delawarr in Ox-

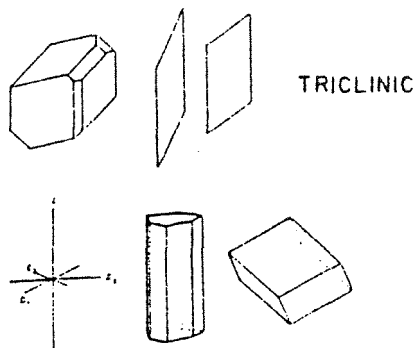

TRICLINIC

ford, England designed by him to transduce the the energy of sound into light. This is an Acoustic-Optic-Energy transducer. There are multiple tones being produced in each of the chambers, which are then resonantly linked with Radionic devices -- which I've learned to use. You implace a piece of equipment, like this quartz crystal, on the plate, and it reproduces images on a glass plate, the energies being released from this device.

I have a group in San Jose who are working with me on this. We do this with no funding. We do this with no outside support. Every bit of what you see here has come from lectures and from a few sales of crystals that have been made. As a consequence the work is beholden to no one except the intention of bringing out the truth and the reality of what we have investigated.

A RADICAL DEPARTURE FROM STANDARD PRACTICE

We have in San Francisco and San Jose a group of about 20 physicians. One of our wonderful compatriots, Dr. Leonard Lask, is here with me, and another man, Dr. Adams, who is practicing here in Los Angeles. For the last year and a half they have been working with these crystals in their medical practice, and have encountered amazing treatments to the body, mind and spirit of a person, to affect Transformational Medicine.

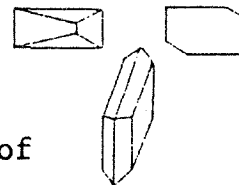

MONOCLINIC

We put into practical operation the teachings of the Tibetan Master Djwal Kul in the book "Esoteric Healing" transcribed telepathically by Alice Bailey. All disease is the result of inhibited soul-mind, all forms, all kinds. The art of the healer is to bring the soul in contact with the body and to give to that body in a loving way its purpose and reason for life. Then the body heals! There is nothing accidental that happens to us. There is intent, purpose and reason for every action which we undergo and experience.

What is the technology of this crystal? The material is made from a single crystal of quartz, which is silicone dioxide. The particular grade of the quartz we are working with at this time is optical grade, piezo-electric quality, two points. It is clear, but above all it has the capacity to respond to minute pressures that one puts into the crystal with one's hand and breath.

By the design of the shape of this crystal, the charge that we release oscillates in much the same manner that a pulsed photon of light radiating back and forth in a laser, comes from a wave-form which is non-coherent, to a coherent beam of energy. So we in turn can make, by the process of intention and breath control, the **energies of the mind coherent** -- one-pointed -- and through this coherency penetrate the various subtler bodies of man, and woman, and release

the attached programs that we store, locked into our beings, and then struggle for the rest of our lives. The body relaxes when the programs are released, becomes whole and heals itself! We do not diagnose or heal. We assist the patient or individual to heal himself or herself.

CONTROL, INSTEAD OF BEING CONTROLLED

One of our most dramatic cases took place in January 1983 when I gave this course in Sausalito, to a man named Mr. Bloom. He came to the podium and asked me to see if I could help him. The primary problem was drug addiction. He'd been addicted to marijuana and cocaine for 35 years! That is not a small period of time. We worked together. I had him look at the source and reason for his addiction. His body began to shake. I told him to release. He released. The next day he was totally free from addiction and to this moment in time he has had no further attachment to drugs. He has written now, two letters of progress report and his life has been transformed.

This man has taken full responsibility for his life. An aspect of joyousness and love have come into his life instead of control and manipulation. He's having one enjoyable ball of a time. He's having fun! That is Transformation.

Another case from our medical group, a black woman, a wonderful black woman who came with her husband. She was practically blind, led in by her husband. She had been treated by Dr. Mortimer Weiss for over two years. He had used acupuncture for two years and had reached a plateau. The makeup on her from a medical point of view was complete, intense examination by all forms. There was nothing more they could do.

This is why Dr. Weiss brought her to our group. We worked together. We tuned in and what I saw was a feeling of rejection. She was the mother of many children. She had raised them and was no longer needed, in her mind. They were gone. Her husband would go off to work and she was no longer needed. She withdrew into herself. I asked her to take a look at that image -- and release it. She did and in less than ten minutes her sight came back! She was able to walk out without help. She read even the watch on her wrist. That's Transformational Medicine!

IT IS BASED ON TUNED CRYSTALS

The crystal is cut critically for the vibrational frequency emitted by the person. I attune the crystal for the physician or the person who wishes to use it. As you draw in a breath and go into your crystal, you send out your carrier wave. You release a charge. This charge now links with a primary vibration induced by the soul of the other person. When the two come together and act in harmony and resonance, I can feel with my other hand that vibration. I can feel physically the harmonious vibrations of our two fields coming together. Then, when we've asked that person to look

and see. I look and see with them. I'm no longer an observer. I'm one with them and supporting them. In that support they can go through the most difficult experience, knowing that they need but reach and I will support them and assist them -- until that critical moment when we get to the hart or root of the difficulty and they feel it. It has a change of vibration! Then I give the command of "Release"! and bring the crystal out and break the feeling. Once we have released that program the body re-establishes its balance, and the process of healing rapidly takes place.

STORED "PROGRAMS" IN BONE

This is the substance of what we have learned in ten years of work, to go and find these "programs" that we store with our mind and heart in our bodies. We found also that records are written in bone! The bony structure of our body stores the result of impact, injury and damage to the structure. We found that a bone fracture, even though the limb heals, stores that program in that area, a program of that injury, the program of the entire event which brought about the damage is stored in that limb, not in the brain. So the active element in our consciousness, normally can not re-create that event and do something about it.

Lady Rayburn, a wonderful woman of Oxford, England, had broken her right leg in a ski accident. Two years later that leg started to degenerate and lay twisted. She asked me to help. We worked together and in five minutes time the memory of the injury was released and the lady from that moment on was normal.

(Shows 35mm slide illustrations of infra-red spectra of water tests.) We can change the fluidic part of our bodies with our intentions. We can change the entire viscosity of our blood stream with the patterns of thought that we release with each breath. These are the implications of these tests.

Now let's release energy to the group. Sit up straight. I'll charge this crystal, rotate it in my hands. Take a deep breath -- and release -- slowly let it out -- then slip your hands up so they are up and comfortable. The palm of one hand is a very useful and meaningful sensor for these types of vibrations. (Vogel takes two quick, deep breaths.) Now I'm beginning to feel it. (He takes another deep breath.) Now breathe in -- breathe out, and as you breathe in again, breathe in your particular need, the need you have at this time to balance the body -- look at it -- release it! Let your breath out. Breathe in -- bring in light, love and clear understanding of yourself. Peace be to all of you who are here. May the love of Christ enter your heart and give you the understanding to know your purpose in life. Take a breath -- release.

This healing crystal was made by myself. This one was made by my son, Marcel Vogel, Jr. I'm so proud of his work. . . Thank you very much and God bless you all. (Tape #353, "Crystals, Healing and Medicine", \$8.16 postpaid, United Church of Religious Science 3251 W. 6th St., Los Angeles, California 90075)

CLIPS, QUOTES & COMMENTS —

A PROVEN FREE ENERGY GENERATOR?

"Free Energy is no longer a dream or a myth. It is now a hard reality. The importance and significance is that this is the first public proof which has been presented. Here John Bedini describes how to build a Free Energy prototype of such a device and make it work. The basic simplicity is amazing. It is not necessary to take someone else's word for it. Try it for yourself with a list of parts, drawings and complete instructions. Imagine running an electric motor for a week, starting with a fully charged battery as the only source of power, and still having a fully charged battery at the end of the week, or longer.

"John Bedini describes the principles involved, which are based on those of Nikola Tesla and Tom Bearden. Development of the prototype is expected to provide efficiencies 800-900% and even greater. The implications alone of this development are enough to fill several volumes. Immediate possibilities are adaption to home needs for auxiliary heat and power and use as a power unit for small vehicles. This booklet contains only 16 pages and should prove to be the most important pages in our immediate history. Words simply cannot express the magnitude of this gift to the peoples of the world. It contains a foreword by Tom Bearden. \$4.75 postpaid."

John Ratzlaff, Tesla Book Company
1580 Magnolia Ave., Millbrae, CA 94030

John Bedini has apparently realized the dream of thousands of would-be Free Energy inventors of putting an electric motor and an electric generator on the same shaft, hoping in vain to generate more than enough electricity to keep the motor running in perpetual motion, or until it wears out. Bedini has solved the problem by adding a resonator to the circuit which oscillates at the right frequency to pump plasma -- matter in the 4th State -- into the battery faster than the motor takes it out. Presumably the basic rate of his oscillator is 8 Hertz -- the rate of the earth's field -- or a higher harmonic thereof. Better get a copy before MIRO suppresses it! I can see one of America's truly great Princes of Darkness, J.P. Morgan, Sr. raging over this -- and Nikola Tesla smiling.

"PEACE THE 21st" - THOUGHT-IMAGE OF PEACE

"This is the second world-wide prayer project which our group, called Peace the 21st, has sponsored. The first occurred March 21st, 1984 and was an outstanding success. We sent out a mere 300 flyers in January and February, inviting people to make and distribute copies to others. By the middle of March we had received enthusiastic calls

and letters from all over the world. One lady in Wales, England called trans-Atlantic to say that her large network of spiritually minded people would participate. Newspapers in Sydney, Australia reported the project and thousands took part. A man in Dayton, Ohio received a copy and single-handedly secured the cooperation of three major Dayton churches.

"Someone in in upstate New York called to say that his crippled children center, 300 strong, would be with us. And in Washington, D.C. a man arranged the participation of five churches and made certain that every member of the U.S. Senate received the flyer. He even delivered copies to the White House! We earnestly request your help to build a second Thought Image of Peace, June 21st, 1984, 7:00 pm to 7:30 pm, your own local clock time.

"Please gather in groups for this effort and do what you feel most comfortable with -- whether prayer, meditation, verbalization, visualization or a combination. Please send photocopies to anyone who may be receptive. Write or call us for our support package of suggested formats, accompanying letters, etc. It will come free of charge."

Peace the 21st, PO Box 6286, Station A,
Toronto, Can. M5W 1P3 (416) 425-6554

THE ALTERNATIVE TO WAR IS PEACE

"As this letter is being written, man finds himself torn between the two extremes of light and shade. Consider: This civilization is one strongly marked by fear and prejudice, and by the war and repression which result. Yet at the same time humanity has surged ahead in its comprehension of the physical world, building a wonderfully complex technology that has done much to improve living conditions in many parts of the world.

"Because these two sides of man's experience are out of phase with each other, fully one-half of the world's manufacturing capability is involved directly or indirectly in making the engines of war and universal destruction. A similar proportion of trained scientific minds are employed exclusively in the perfection of devices whose sole purpose is to inflict horrible pain, or to destroy the living bodies of their brothers, or to reduce to rubble the beautiful structures that so many have labored to build.

"And now your race has fashioned for itself the ultimate weapon of annihilation: the nuclear bomb. Tens of thousands of these doomsday machines have been installed on so many missiles that the earth stands constantly a mere thirty minutes from the complete eradication of all life-forms from its surface. This planet literally bristles with its own destruction.

"It is surely clear that it is a man's thought which has brought him to this perilous place in history. If he were not so gripped by fear, prejudice and hatred, the misuse of his technical skills would never have arisen. And since the seeds of the current danger are

found in the realm of thought, there too lies the hope of rescue.

THE POWER OF POSITIVE THINKING

"Mankind little realizes how powerful is its collective thought. Nor is it understood that a mere handful of individuals who align and project their thinking -- whether in the form of prayer, meditation or visualization -- can strongly influence the motives and conscious perceptions of a vastly greater number of their fellows.

"Already this concept has been proven. In England during the Second World War, a movement which called upon participants to pray for peace each evening for one minute was so successful that the Germans concluded the British had developed some sort of secret weapon. More recently, a concerned group concentrated positive thought on the city of Atlanta over several months and a clear drop in the crime rate resulted.

"We ask that you lend your efforts in a similar project, by selecting a date and time for the creation of a powerful Thought Image of Peace -- one which can have a profound effect on the attitudes and motivation of millions of others through subconscious communication. One way to achieve this is through the power of prayer; for it sends out a clear call to the highest and holiest realms for help -- and that help is always forthcoming. Another procedure is that of meditation and the visualization of a sane, peaceful and loving world; for this, too, generates a wonderful force for good that can reach vast numbers.

"We implore you to cooperate together for the rescue of humanity from its own folly, in the quietness of your inmost thoughts and prayers lies the key to the preservation of this planet and all who inhabit it."

ON THE VERGE OF RUIN

"I am now practically an American, having been in the U.S. for 15 years and married to an American. I cannot confide my distress in anybody since most people do not believe in the existence of the supernatural. My husband worries and thinks I might be a mental case. Being a Haitian, I have had to deal with voodoo, unwillingly, all my life. As a result of a quarrel with a distant relative, I came very close to being possessed two years ago, and have been since struggling to free myself from the influence of bad spirits. Symptoms such as mental confusion, inability to think clearly or concentrate, without counting frequent nightmares, fear, anxiety and stress, have made it difficult for me to hold a job or study. I have been out of permanent employment for a year.

"In writing to you I am hoping you will take an interest in my situation and put me in contact with psychics, hypnotists, etc., who are interested in this area of knowledge. I have experiences I can share with them and feel that they, in turn, might offer me moral support and help. I am an energetic, ambitious and motivated person.

It takes a big problem to put me in this pitiful predicament. I am really desperate. Please give my case your prompt consideration."

R.M., Englewood, New Jersey

Another proof of the power of pagan magick -- and of the danger of crossing up a pagan magician -- unless one is prepared to cope with the inevitable vindictive response. For the sake of her own moral and spiritual development this lady should learn to protect herself from psychic attack. Two years of suffering should be motivation enough to do protective rituals night and morning without fail, until the attacker gives up or is himself or herself destroyed by their evil output, bouncing off the wall of light so created and returning on its magnetic track to its creator. So, a copy of "Retro Me, the Art of Psychic Self-Defense" is on its way. Hopefully, she will find enough energy to put the instructions to good use.

EEMAN SCREENS MIGHT HELP, TOO

"I want to thank you for the Eeman Screens you made for me. I have a great amount of tension in my body because of daily 'dead lines' in my many obligations. Every few days, three or four days apart, I place the Screens on the bed and lie down on them as instructed, for approximately 40 minutes, and my body and mind are relaxed again and ready to go."

S.M., Pasadena, California

Yes, the Screens are a simple and proven way to restore polarity or balance to the electro-static field of the body. Eeman found and proved this way to circumvent mental and emotional blocks in the subconscious. \$15 a set. \$3.00 for the brochure.

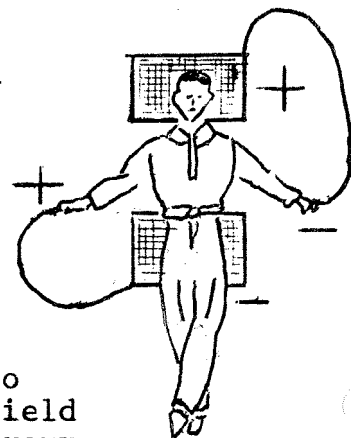

SHIRLEY MACLAINE: UFOs AND A STARTLING COINCIDENCE



"Some years ago I noticed a small ad in Fate Magazine announcing a contactee book called 'Date With The Gods' by Charles A. Silva (1). I bought the book and found it to be a most unusual contactee story purported to be the truth. As there were no reviews nor any comments on this work in the American UFO magazines I began to suspect the whole story to be fiction, especially since a letter to the author remained unanswered.

"'Date With The Gods' is basically an autobiography of Mr. Silva, a publicity man for motion picture producers. While on vacation in the Andes mountains in Peru he meets an 'extraterrestrial' girl named Rama, who not only becomes his lover but gives him a whole new philosophy and relates the work of her people on earth. She claims to be from Ganymede, one of the moons of Jupiter. After several UFO experiences, among them a ride in one of

the Saucers, Mr. Silva is convinced of the basic validity of Rama's message and he is asked to write a book about his experiences.

"I was intrigued by this story. It was written in a ruffer tone and with lots of humor, a not so common quality in UFO literature. But still there were the false prophecies -- California to be destroyed in 1982 -- and some Christian claptrap -- 144,000 to be saved by Saucers when Armageddon strikes -- thrown into a basically interesting contactee story. I read the book and left it at that as no one seemed to have any information on the author.

"Shirley MacLaine's latest book, 'Out On A Limb' (2) is possibly a confirmation of the Silva contact. Among several other interesting adventures Ms. MacLaine relates a trip to the Andes mountains of Peru together with her American friend David. They visit some mineral wells not far from the city of Huancayo as described in 'Date With The Gods'. While vacationing in the mountains David reveals that this is the place where he on several occasions has met his extraterrestrial lover and teacher, Mayan, a petite woman with long black hair and dark, slanted eyes who claims her home planet is in the Pleiades. This parallels almost exactly the story in 'Date With The Gods', except Rama claimed to come from Ganymede.

"Ms. MacLaine really doesn't know what to think of her friend's story but notices that just about every native in the district has seen the flying discs. I draw attention to this parallel with the hope that some of our American colleagues can unravel more details for these interesting cases. (1) Charles A. Silva: 'Date With The Gods', Coleman Graphics, Long Island, New York 1977. (2) Shirley MacLaine: 'Out On A Limb', Bantam Books, New York 1983. Also in Swedish as 'Ut pa yttersta grenen', 1983."

Hakan Blomqvist
AFU Nyhetsblad
May-Dec 1983 Newsletter
Box 11027, 11 Norrkoping
S-600 Sweden

MORE WANTED ON "THE REGENT OF THE WEST"

"I enjoyed the March-April Journal so much, and found that article 'Heritage From Atlantis' so illuminating! And on the back, 'The Fourth Way' and all -- or most all -- of the things that magnificent man has done. I knew of him, the adept, Prince Rakoczi, but not that he had been Sir Francis Bacon before; or that Francis had supervised the translation of the King James version of the Bible! I wish you'd write more about the lives and works of Sir Francis!"

M.J., Los Angeles, California

That would take volumes, and all we can do in the Journal is try to tease the reader into looking more deeply into a subject on his or her own. But 24-J-A, "The Fourth Way, the Way of the Adept or Sly Man", 68 pages and illustrated, is a good beginning on the man, or Soul, who more than any other laid the foundations of our Western civilization. \$3.50 postpaid.

July-August 1984 RR, Page 27

LTGEN BOND KILLED IN CRASH OF
SECRET TEST CRAFT

Las Vegas (AP) April 27, 1984

"A three-star Air Force general was killed Thursday when the secret test craft he was flying crashed on the Nevada Test Site, the Air Force said. LtGen Robert M Bond was killed when what the Air Force called 'an Air Force specially modified test craft' crashed on the site about 10:45 a.m.

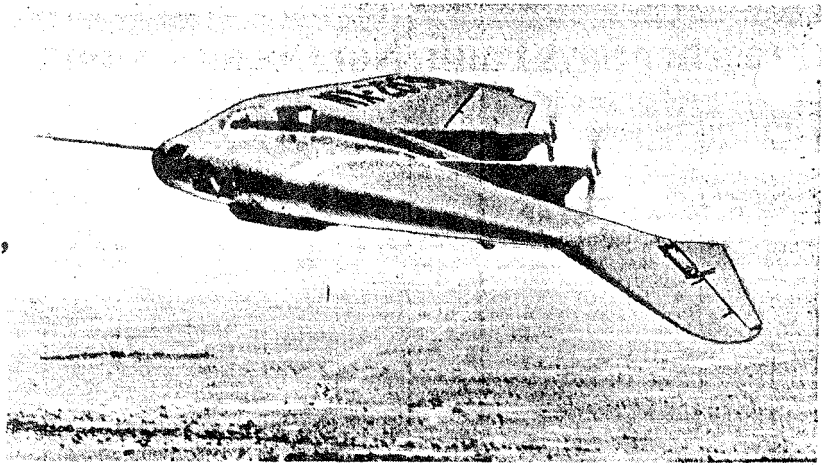

"Bond, 54, was vice commander of the AF Systems Command, according to a statement issued from the command at Andrews Air Force Base near Washington. Air Force officials refused to say what type of plane Bond was flying.

"But officials at Nellis Air Force Base refused to acknowledge that a plane had crashed until Andrews AFB reported it about seven hours later. A portion of the test site, known as Area 51, is the site of super-secret government military tests."

Knowledgeable UFO researchers in Southern California have been told that Area 51 is the site for testing American-built Flying Saucers; so LTGEN Bond may have been testing this kind of super-secret aircraft. This suspicion is strengthened by following news releases by the Ministry of Disinformation of the U.S. Air Force. The first was that the general was testing a Stealth bomber "with low radar, infrared and optical signatures" hard to detect by enemy observation systems, and that the Stealth bomber might be a revival of the Northrop "Flying Wing" of the early 1940s. The second release was that the general was testing a modified Russian MIG jet-fighter. Take your choice.

SCHOOL PRAYER ADVOCATES KNOW NOT WHAT THEY DO!

"No matter how sincere our President and others may be, there are obviously some areas regarding this School-Prayer amendment they have not thought through. This is not a question of freedom of worship; rather it is a matter of religious belief itself. I deny the right of any two-thirds majority to control or determine such an issue. Caesar, though he may have all temporal power, has no authority on matters of conscience. With full respect for the processes of law and government, I deny the authority in Congress or the government of the United States to control or regulate in matters of religious belief. . . We are free to send our children to a church-related school of our choice whose doctrines and prayer we accept; but when we send our children to public schools, what prayers and doctrines are we endorsing? Let me propose some questions:

"Prayer To Whom? Shall we pray, 'Oh thou great and understanding Bahallah, as all of mankind is spiritually one. . .'; or shall we address our prayer to Buddha, 'Oh enlightened One. . .'; or shall we chant with the Islamics, 'There is but one God but Allah, and Mohammed is his prophet. . .'; or, more familiarly, 'Hail Mary, full of Grace, the Lord is with thee, blessed art thou among women and blessed is the fruit of thy womb, Jesus. . .'?"

"Forgive me if I appear to be ridiculing any beliefs, but I trust I have made my point, for I cannot agree with prayers, doctrines or beliefs of those who say it does not matter what kind of prayer we have. I cannot accept a 'religion with no offense to anybody'. True believers want prayer they can accept and welcome for themselves and for their children."

Dr. Bryce B. Augsburg, Baptist Minister
"Church and State" Magazine, April 1984

We might mention in passing, as our Flying Saucers fan out through the Solar System, that the Bahai is the only world religion that welcomes contact with advanced beings from other Systems; and in their home nation, Iran, the Bahais are being slowly but surely decimated by the fanatical followers of the false Mohammed, Thoth-Gabriel. And, according to pictures we see frequently in the papers, President Reagan's spiritual advisers are Roman Catholic Bishops -- with an occasional word from the Pope; so the President's guidance on the School Prayer issue is rather obvious.

BIG BROTHER IS WATCHING

"At any time when my radio is tuned to Radio Moscow or Radio Peking, a lot of scanning sounds are heard also, although there are only three other houses within a hundred yards of me. Could it be there is a satellite scanning and recording the location of radios tuned in to such stations?"

W.W.G., Prince George, British Columbia

THE PROTECTIVE POWER OF EUCALYPTUS OIL

"Upon sleeping with the Six-Pointed Star under my bed I awoke with a strong message, 'Use what you have, to get more'. It referred to the Eucalyptus tree as protective medicine. I boiled the young leaves and inhaled the fumes. I also purchased Mentholatum, which carries the healing and protective power of the Eucalyptus.

"The creeper is still with me. At times I'm prodded awake, as if with a stick tickling my nose, wriggling furiously inside my nostril. My nose is sore from rubbing and banging it. As it keeps on I am able to see just what an Astral creature can do to a physical being. I rub Mentholatum on nose and get immediate relief.

"Evidently the magic of the Eucalyptus offsets the magic of the Lama. I never realized that trees have an Astral body also! Half asleep I sense the Lama at his shrine, doing ritual, and reaching out

to tickle the Torma with my picture and name on it. The Torma is a six-inch mound of dough used in Tibetan Lama ceremonies, impregnated with an 'aka thread' connection of name and picture. The ritual creates a time-space warp; so he tickles my nose endlessly, either himself or by use of an invisible creeper.. Never before has the Astral world been so vivid to me and so clearly displayed. If I took my Astral body away I bet I wouldn't be able to be toyed with this way, but I am not trained in the manifesting of the Astral. I am grateful for the Eucalyptus tree protection and the Six-Pointed Star symbol."

A. Dorge, San Francisco, California

For every poison there is an antidote and black magicians can generate powerful "poisons" indeed. You are learning a strong lesson in discrimination, between the real Buddha, whom you worship, and the false Buddha, Enochissa, the Moon God who guides your Lama teacher.

WHAT SAYS THE YADA ABOUT PRIESTCRAFT?

"Far back in time the Priestcraft have taken away from us our own initiative to act upon our own thinking. We flee from this -- the Devil. We fear to put our souls in jeopardy and so we flee from learning. The Priestcraft has said Necromany, which you are witnessing right now, the calling up of spirits, is evil! You know why they teach this? So you will not be given the opportunity to learn the truth about your own survival -- about your own Divinity! For thousands of years religion has been doing this kind of thing."

"Do the priests know what they are doing?" asked a sitter at the seance.

"No, they are merely acting upon the orders of their masters."

"Do the religious Hierarchies know?"

"Yes," replied the Yada.

"Does the Pope know?"

"All there is," replied the Yada, "is the Light and the Dark, the positive and the negative. They not only know how to exert the inner forces for their benefit, but they know also of the penalty. Bu they are willing to face that penalty for something else which I cannot tell you."

"They teach their priests black magic?"

"Let us go back to Catholicism -- to mediaeval times. The people were taught that to bathe was very bad. Why? Because the teaching that one received in the temples -- those teachings are received in what is called ritual form -- this practice of ritual is magic and it creates control vibrations which the physical body absorbs through the nervous system; and to put the body in cold water destroys the vibrations, so the priests do not want their followers



YADA DI SHI'ITE

to be washed."

"Catholicism," agreed a sitter. "In India, in Tibet, why do they stay away from water?"

"Some Hindus bathe in the Ganges," observed another sitter.

"Yes," agreed the Yada, "but others do not go near the water. In a city with over 10,000 priests (Lhasa?) they are living off the blood and energy of the lay mind in that city. You here (in California), your priestcraft are living off your blood and energy. As long as you fear you will permit these to give you the whiplash. The secret lies right here in Isasa -- in Wisdom -- and in acquiring this wisdom you will find you are that God. You are that Divine."

"I am all of these things. I just have to become aware of it?" asks Irene Probert.

"I come to you many times. Use boy's body (Mark Probert). Some say this cannot be. I could not be God. Yet it is all right to listen to priest say God made you in His image and likeness. This? (body) No, this (mind). Every day, every moment, every second of what you call the passage of time in the physical world and in all dimensions of time, you, man and woman, are going through initiations until you take the last initiation and become consciously God. Does this mean this part of you will be absorbed in the Great Mind? There is no other Great Mind! You are it! Can the snake swallow itself?"

"There is hope for us then?"

"I hope so. And every prayer of every day is done hoping it will put us in tune with a great Reality. Whatever we are doing we are seeking a greater state of Reality." (Frome BSRF 9-D, Seance Memoranda of the Inner Circle, San Diego, Cal. 1952. \$3.00 postpaid.)

AH, THOSE POTENT ELF RATES!

"At Kathleen Joyce's place in Los Lunas, New Mexico I saw the TENS device Ed Skilling builds (May-June 1982 RR) and they said to me it is quite powerful. They had a lady try it out and she was knocked unconscious! Wow! So I abstained from trying it myself, not wanting to be flattened in New Mexico."

They, or she, just happened to set the TENS at the strobe rate which puts her in trance temporarily. If you had tried the TENS at that rate it probably wouldn't have bothered you at all -- though everyone does have a flicker rate which will entrance them quickly. It varies from person to person and some people have a lower threshold of "hypnosis tolerance" than others.

"I very much wonder whether Dr. Andrija Puharich's book 'Time No Longer' will ever be printed? Do you know by any chance if he had some extra copies made and stored away in a safe place? If so, he could try publishing in England."

L.vH., Armadale, Western Australia

July-August 1984 RR, Page 31

It seems highly unlikely that the MIRO curse on Dr. Puharich's writings and publications has been lifted, and it isn't easy for an author to print and distribute his own works after having them printed and distributed by a big, national firm for years. Anyhow, Dr. Puharich is too busy doing research and lecturing; so, you'll have to be satisfied with our "Phasing In The New Race" brochure, the interview in which Doc describes his experiences with these superkids from other planets, volunteers to help us survive the end of the Piscean Age. (BSRF 2-H, \$3.50 postpaid)

"ON A SLIDE OF LIGHT"

However, one of the ETs Dr. Puharich did research for "Time No Longer" has gotten out her own book and published by McMillan, New York, 1981, at \$12.95 a copy. Greta Woodrew isn't really a superkid but a successful business woman in her 40s. From hypnotic sessions in the shielding Faraday Cage in Doc's former home in Ossining, New York, Greta learned that her planet of origin is Ogatta, in the Globular Cluster M-92 in the astronomer's star catalogue. The title of her book, "On A Slide Of Light", is their term for space travel. The Ogattans are only one of 26 advanced civilizations from without and within the solar system dedicated to rolling back the tide of Evil which threatens to engulf the earth and destroy it. It is a great comfort to know they are here and we can expect more and more of these ETs to "stand up and be counted" as the conflict heats up. You can get a copy of her book directly from her, through her S.T.A.R. Foundation, 448 Rabbit Skin Road, Waynesville, North Carolina 28786, add a couple of bucks for postage and handling.

PYRAMID STONES MAN-MADE?

"Here are copies of a press release and newspaper clippings dealing with current research findings on the Egyptian pyramids, both of which I received with a recent book purchase, 'The Book of Stone - Alchemy and Pyramids', by Dr. Joseph Davidovits. In essence, this French chemist, Director of the Geopolymer Institute at Barry University, Miami Shores, Florida, has analyzed and tested samples of stone from the Great Pyramid of Giza and has found them to be man-made.

"His analysis shows that the stone is composed of a limestone fossil-shell substance along with a mineral binder containing calcium phosphate and various other alumino silicates. The blocks were not cut or hauled. He theorizes that they may have been cast like cement at the construction site using an here-to-fore unknown process of re-assembling fragmented stone through a molecular binding process.

"Further testing -- through X-diffraction, X-ray analysis and thin section -- on five different casing stones from the exterior of the pyramid, as well as from its inner chambers, proves conclusively that they are man-made. Well preserved organic fibers, which appear to be either human or animal hair, were found inside these stones. The stones are of such high quality that they were unable to be distinguished from natural stones -- until now. Dr. Davidovits has

also reproduced the method of making such stone and has set up a research program at Barry University to study the many ecological uses for man-made stone. He claims that it can be easily produced at room temperature with pressure or other hard technology. Getting back to what is presently known about the Pyramids from occult knowledge, or through channeled information, I've heard that the stones were molded from a secret mixture of sand and straw. Perhaps a few animal hairs could also have been thrown in to complete a formula calling for samples from the three kingdoms: Mineral, Vegetable and Animal."

G.Z., Broadview Heights, Ohio

Let's not leave out the Fourth Kingdom, Gunnar, the life-force of the workmen flowing from their hands into the mix -- with the priest nearby invoking the blessings of the Gods, the Fifth Kingdom. "The Book Of Stone" by Dr. Joseph Davidovits, and a related 110 minute cassette tape, are available from the U.S. Distribution Center, 13119 Glenfield, Detroit Michigan 48213. \$11.95 for either book or tape.

A WARNING ABOUT FINISHED CRYSTALS

"The Di-pyramidal shaping of natural quartz crystals (custom cut at \$425 each) impresses the feelings of the cutter at the time of his work. Suppose he's not in the best of moods? Rock quartz crystals are either male or female. Perhaps by cutting he brings the field into neutron range (my pendulum talking); whereas Lithium quartz crystal does that automatically through Nature's gift, a perfect golden spiral and neutron field every time. The rock quartz energy spiral is white and sometimes fuzzy. Analysis of the Golden C lithium crystal shows that it contains 35% Lithium, 61% Beryllium and 4% Gallium. Man who analyzed it said, 'It is a miracle, providing youth energy'. Silicon Valley uses Gallium in computer chips as it wears/lasts much longer than plain quartz. I thoroughly enjoyed the Journal with the article on the Earth-forms (animal-souled humans). I think I know a few."

H.A., Oceanside, California

Lithium Crystals, in a hand-blown, cute little glass container on a short gold chain, can be obtained for \$10 postpaid from the Golden Crystal Lady, Alzet Kryztalz, 163 Los Angeles Blvd., San Anselmo, California 94960 or (415) 457-9597.

IS ROCKEFELLER DUMPING REAGAN?

"Spotlight", May 18, 1984: "I now believe that the owners of the Federal Reserve Bank have decided to double-cross President Reagan the way they did Jimmy Carter. Apparently the White House is becoming concerned because Larry Speakes made a public statement recently asking the Fed to relax its tight money policy, which it decided upon last month. . . If Congress would reduce the budget deficit by \$50 billion this month, there would still be just barely enough time for the Fed to drop interest rates to save the economy from going back into

a depression by Election Day (the tactic which lost Carter the 1980 election). . . The thing that makes me think the die is cast is the fact that Rockefeller's Chase Manhattan Bank led the current increase in the prime interest rate to 12 $\frac{1}{2}$ %. The significance of Chase leading the prime rate up is that Rockefeller wants interest rates to rise (knowing) it will certainly defeat Reagan next November. . .

"It can only mean that Rockefeller has decided to dump Reagan just the way he dumped Carter, even though Rockefeller sponsored Carter and financed his first campaign. When he decided he didn't want Carter re-elected, he then backed George Bush for president. When Reagan defeated Bush in the Primaries, Rocky invited president-elect Reagan to dinner and made a deal with him to have Bush as vice-president, in return for Rockefeller's backing.

REAGAN WILL FIND OUT WHO'S BOSS

"But Reagan has not been the most cooperative president from Rockefeller's point of view. . . Reagan is not the 'one worlder' that Rockefeller hoped to persuade him to become. He is too anti-communist, especially in Latin America. . . Although the president was persuaded to go to Red China for commercial purposes, he used the opportunity to lecture the Chinese on the defects of socialism and the virtues of free enterprise. That was not to Rockefeller's liking.

"Fritz Mondale is far closer ideologically to Rockefeller. After all, he was Carter's vice-president, whom Rockefeller sponsored. It would be natural for Rockefeller to sponsor Mondale again. . . The interest rate rise could result in the demise of the Fed. I do not think the president will sit idly by watching interest rates rise. . . with the election at stake the president simply will not tolerate higher interest rates the way he did in his first year. The president was quoted then as saying 'Why do we need the Fed anyway?' (This is a dangerous statement to make, by anyone in a high power position in this country. It can be political suicide.)

"But if I could talk to the president, I'd explain about the Fed. There is no legitimate function of the Fed that the U.S. treasury could not do. . . The only Constitutional basis for the Federal Reserve's existence is the 'general welfare' clause. The power to cause a business depression is clearly not in the general welfare. This is just the opposite in fact. There should be a law with a criminal penalty for anybody doing anything that deliberately causes a business depression that bankrupts thousands of farmers and businessmen and causes massive unemployment. What politician could not be elected on that proposal? Such a law would put Paul Volcker in jail. It would be interesting to see who might oppose such a law. . . "

James Sibbet

We still get inquiries about the Curse of Tippecanoe and whether or not Reagan -- elected in a Zero year, 1980 -- will finish his term in office. Sibbet's article in "Spotlight" suggests one physical plane force which might be an effective agent for the Curse.

HYDROGEN POWER AND ITS PROBLEMS

"I have a friend who is a mechanical engineer and who goes to Christchurch from time to time. He is greatly interested in this subject of hydrogen-from-water for fuel. So he has sought out Archie Blue (your article in Oct. 1979 RR, 'Yup, His Car Runs On Water') to find out something about this gadget. Blue is 74 and time is running out on him. At his first visit Archie was cagey, said he might having 'something to show you' next time he came to Christchurch. My friend did get in during his next trip and was shown that Blue could produce hydrogen gas to run a small stationary engine, but the problem was he could not produce enough gas with that setup to keep the engine running for any length of time -- which might also have been a coverup. So that's where we are at present."

Les White, Nelson, New Zealand

REPORT ON GEORGE VAN TASSEL'S "INTEGRATRON"

"I drove over to Giant Rock the other day, from my home in Yucca Valley (California) and checked the condition of the Integratron with field glasses. It is very poor. The plywood dome is badly checked and some seams have opened up. Apparently there is no upkeep since Van's passing 1979. There are maybe only four or five people finish the machine to Van's concept. . . but in my opinion it will never be finished and, unless some upkeep is done on the building and soon, it will be useless. Just how much of the material that was in storage in the dome is left, no one knows but Dorris Van Tassel."

H.K., Yucca Valley, California

Is it worth another life to finish the Integratron and get it functioning? The Force which removed George Van Tassel suddenly from the scene in 1979 is still making its vindictive presence felt. At the time we talked with his widow last October, three little surveillance electronic "bugs" had been discovered and deactivated in her home. Her house was shot at one night. The bullets easily penetrated the thin walls of her mobile home and lodged harmlessly in the upholstered living room furniture. A nutty neighbor placed an explosive device under the house, then called her in a thinly disguised voice to see if she had discovered it. There are millions of emotionally disturbed, psychotic humans on the planet available to the "insectoid" invaders to make trouble. Their goal is to return the earth and its humans to a Stone Age level more suitable to their Involutionary needs. Fortunately there millions of other men and women of good will who are not psychotic! Their Will-to-the Good constitutes a countervailing Force which, under the direction of the Guardians, will see us successfully into the Aquarian Age.

No doubt the Russian Woodpecker ELF waves at 10 Hertz are useful to the Insectoids for their sinister hypnotic purposes, supplying a constant carrier wave for mental manipulation of unsuspecting, unawakened humans; but for those who are awakened, the 10 Hertz signal only serves as a stimulus to greater good deeds!

PHASING IN THE NEW RACE - The 1977 interview of Dr. Andrija Puharich covering his research of over 30 Superkids of the coming Sixth Sub Race. MIRO blocked publication of Doc's book "Time No Longer" about these kids and their psychokinetic powers but we have this excellent interview with several New Age editors about his learning experiences with the kids, not long before his Ossining, New York home was burned to the ground, and years and years of valuable research material consumed with it!. Time No Longer is an oblique reference to the Fifth Dimension, a world of Causes. This 3-D world is a world of Effects. Illustrated. Postpaid. . . \$4.00

THE COMING OF THE GUARDIANS - Compiled by Meade Layne. Contains the 4-D explanation of the origin of the Flying Saucers (mat and de-mat), developed in the late 1940s. Information about the outer space Guardians of the planet and their patrol ships, received through Rolf Telano (a walk-in from Venus), and the Communications from the Inner Circle giving us our first intelligent evaluation of the Flying Saucers as piloted, interplanetary and inter-plane vehicles. Contains biographical material on the members of the Inner Circle who communicated through Mark Probert, and notes on his mediumship, and a chart of the Etheric Zones around the earth from which the UFOs materialize and to which they return with mission accomplished. Illustrated, Postpaid. . . . \$4.00

THE REALITY OF THE CAVERN WORLD - Transcript of an illustrated talk about the interior of the earth and those who live in it, by the Director of BSRF. This includes comment and analysis about the following: The Origin of the Serpent Race, Lord Byron's story of a Magical ceremony which evoked Cavern elementals and Lucifer himself in an Alpine chalet, the Shaver Mystery and the Deros, the famous Catacomb of Hal Saflini on Malta, a Cavern entrance, human dwarfs and 20-ft giants, the Kingdom of Pan - Fauns and Satyrs, the Plane s of Consciousness in the Earth, a Guided Tour through the Interior, and a message from an Earth God. . . . \$3.00

- - - - - CALIFORNIANS ADD 6% SALES TAX - - - - -

The JOURNAL of Borderland Research

Bulk Rate U.S. POSTAGE PAID Vista, Calif. Permit No. 42

A Publication of:
Borderland Sciences
Research Foundation
PO Box 549, Vista,
California USA
92083-0190